



Battery Features

- High capacity Lithium Cobalt Oxide (LCO) pouch cell
- High energy density, low cost and long cycle life
- Stable energy for applications requiring high power
- Low self discharge rate and low maintenance
- Available in a wide range of sizes and capacities

The Vertical Partners West Advantage

Our long history of designing battery and charging systems makes VPW your ideal power management partner for OEM projects. We are a U.S. based supplier with multiple highly vetted mass manufacturing partner facilities in Asia. Working closely with your design team, VPW delivers just the right solution designed to fit your application and budget.

Let our experience with advanced chemistries, sophisticated battery charging & management systems and our expertise with complex assemblies power your project. Leverage our vast buying power, door-to-door import ease and low minimum order quantities for your next premium battery or charger project.

Performance Characteristics	Typical
Capacity	22Ah
Voltage (Nominal)	3.7V
Discharge Energy	81.4Wh
Weight	0.415 kg ± 0.02
Specific Energy	196Wh/kg
Max Cont. Discharge Current @ 25°C	330A
Max Pulse Discharge Current @ 25°C, 10s	660A
DC Resistance	≤2 mΩ
Peak Power	≥2442W
Specific Power	≥5884W/kg

Cycle Life	Typical
100% DOD Cycles @ 25°C, 2C/5C	≥200 cycles*

*Cycle life to 80% of rated capacity - 2C Charge / 5C Discharge

Operational Range	Typical
Upper Voltage Limit	4.2V
Lower Voltage Limit	3.0V
Charge Temperature Range	0°C ~ 45°C
Discharge Temperature Range	-20°C ~ 60°C

Battery Characteristics

Charge/Discharge Curve - SoC %

Charge/Discharge Curve - Capacity/Ah

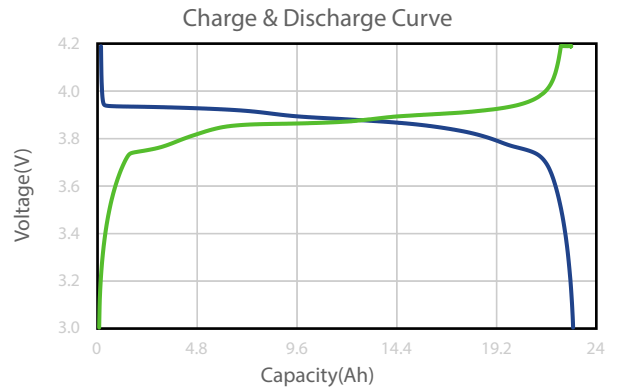
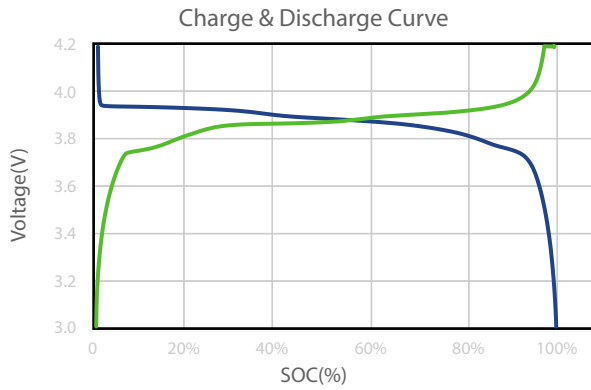

Mechanical Characteristics

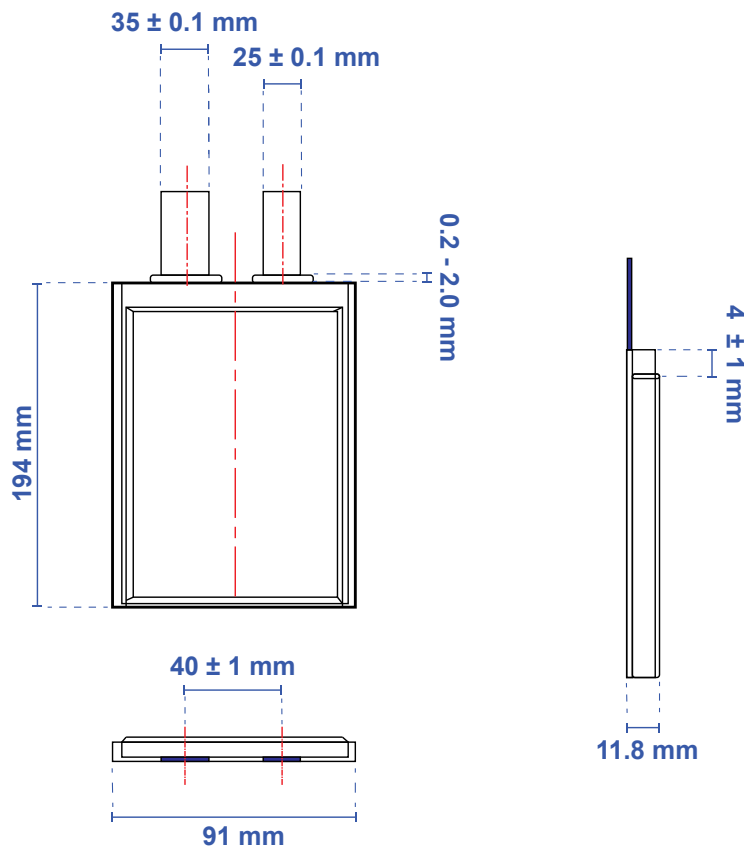

14028 North Ohio Street, Rathdrum, Idaho 83858 • (800) 705-0620

Email: sales@vpwllc.com
 Web: vpwllc.com

The information contained herein is provided solely for the purpose of general explanation and illustration and is subject to modification without notice. No warranty or guarantee is given in regard to the information contained herein or the referenced products. Please contact Vertical Partners West® for the most current and relevant product information for your application.